

| TEST REPORT | |
|--|---|
| Engineering Recommendation G98 Issue 1 Amendment 4 June 2019 Requirements for the connection of Fully Type Tested Micro-generators (up to and including 16 A per phase) in parallel with public Low Voltage Distribution Networks | |
| Report reference No. | 190411083GZU-001 |
| Tested by (printed name and signature) | Sunny Lin Engineer |
| Approved by (printed name and signature) | Jason Fu Technical Team Leader |
| Date of issue | 12 Dec 2019 |
| | 36 pages |
| Testing Laboratory Name | Intertek Testing Services Shenzhen Ltd. Guangzhou Branch |
| Address | Block E, No.7-2 Guang Dong Software Science Park, Caipin Road, Guangzhou Science City, GETDD, Guangzhou, China |
| Testing location | Same as above |
| Address | Same as above |
| Applicant's Name | Shenzhen SOFAR SOLAR Co., Ltd. |
| Address | 401, Building 4, AnTongDa Industrial Park, District 68, XingDong Community, XinAn Street, BaoAn District, Shenzhen, China |
| Test specification | |
| Standard | G98 Issue 1 Amendment 4 June 2019 |
| Test procedure | Type Verification |
| Non-standard test method | N/A |
| Test Report Form No. | G98/1b |
| TRF originator | Intertek |
| Master TRF | dated 2019-06 |
| Test item description | Solar Grid-tied Inverter |
| Trademark |  |
| Manufacturer | Same as applicant |
| Factory | Dongguan SOFAR SOLAR Co., Ltd. 1F-6F, Building E, No.1 JinQi Road, Bihu Industrial Park, Wulian Village, Fenggang Town, Dongguan City |
| Model and/or type reference | SOFAR 1100TL-G3, SOFAR 1600TL-G3, SOFAR 2200TL-G3 SOFAR 2700TL-G3, SOFAR 3000TL-G3, SOFAR 3300TL-G3 |

| | | | | |
|------------------|-------------------------------|--------------------------|--------------------|--------------------|
| Rating(s)..... : | Model | SOFAR 1100TL-G3 | SOFAR 1600TL-G3 | SOFAR 2200TL-G3 |
| | Max.PV voltage [Vdc] | 500 | | |
| | PV voltage range [Vdc] | 50-500 | | |
| | PV Isc [A] | 15 | | |
| | Max.input current [A] | 12 | | |
| | Max.output power [W] | 1100 | 1600 | 2200 |
| | Max.apparent power [VA] | 1100 | 1600 | 2200 |
| | Nominal output voltage [Vac] | 230 | | |
| | Max.output current [A] | 5.3 | 7.7 | 10.6 |
| | Nominal output Frequency | 50Hz | | |
| | Power factor range | 0.8Leading – 0.8 lagging | | |
| | Safety level | Class I | | |
| | Ingress Protection | IP 65 | | |
| | Operation Ambient Temperature | -30°C - +60°C | | |
| | Model | SOFAR 2700TL-G3 | SOFAR 3000TL-G3 | SOFAR 3300TL-G3 |
| | Max.PV voltage [Vdc] | 550 | | |
| | PV voltage range [Vdc] | 50-550 | | |
| | PV Isc [A] | 15 | | |
| | Max.input current [A] | 12 | | |
| | Max.output power [W] | 2700 | 3000 | 3300 |
| | Max.apparent power [VA] | 2700 | 3000 | 3300 |
| | Nominal output voltage [Vac] | 230 | | |

| | | | | |
|---|-------------------------------|--------------------------|------|----|
| | Max.output current [A] | 13 | 14.5 | 16 |
| | Nominal output Frequency | 50Hz | | |
| | Power factor range | 0.8Leading – 0.8 lagging | | |
| | Safety level | Class I | | |
| | Ingress Protection | IP 65 | | |
| | Operation Ambient Temperature | -25°C - +60°C | | |
| | Software version | V 2.00 | | |
| Summary of testing: | | | | |
| The sample(s) tested complied with the type test requirement of G98 Issue 1 Amendment 4 June 2019 | | | | |

Test case verdicts

Test case does not apply to the test object .: N/A

Test item does meet the requirement: P(ass)

Test item does not meet the requirement: F(ail)

Testing

Date of receipt of test item: 08 Oct 2019

Date(s) of performance of test: 08 Oct 2019 – 05 Dec 2019

General remarks

The test results presented in this report relate only to the object tested.

This report shall not be reproduced, except in full, without the written approval of the Issuing testing laboratory.

"(See Enclosure #)" refers to additional information appended to the report.

"(See appended table)" refers to a table appended to the report.

Throughout this report a point is used as the decimal separator.

When determining the test conclusion, the Measurement Uncertainty of test has been considered.

This report is for the exclusive use of Intertek's Client and is provided pursuant to the agreement between Intertek and its Client. Intertek's responsibility and liability are limited to the terms and conditions of the agreement. Intertek assumes no liability to any party, other than to the Client in accordance with the agreement, for any loss, expense or damage occasioned by the use of this report. Only the Client is authorized to permit copying or distribution of this report and then only in its entirety. Any use of the Intertek name or one of its marks for the sale or advertisement of the tested material, product or service must first be approved in writing by Intertek. The observations and test results in this report are relevant only to the sample tested. This report by itself does not imply that the material, product, or service is or has ever been under an Intertek certification program.

The test report only allows to be revised only within the report defined retention period unless standard or regulation was withdrawn or invalid.

General product information:

The unit is a single-phase PV Grid inverter, it can convert the high PV voltage to Grid voltage and feed into Grid network.

The external circuit breakers or fuses for PV array and Grid connection are required which are stated in the installation manual.

The unit is providing EMC filtering at the PV side and AC side. It does not provide galvanic separation from PV side to Grid.

The unit has two controllers. The master controller A monitor the invert statue; measure the PV voltage and current, bus voltage, AC voltage, current, GFCI and frequency, also communicate with the slave controller B

The slave controller B monitor AC voltage, current, frequency , GFCI and communicate with the master controller A
The relays are designed to redundant structure that controlled by separately.

The master controller and slave controller are used together to control relay open or close, if the single fault on one controller, the other controller can be capable to open the relay, so that still providing safety means.

The topology diagram as following:

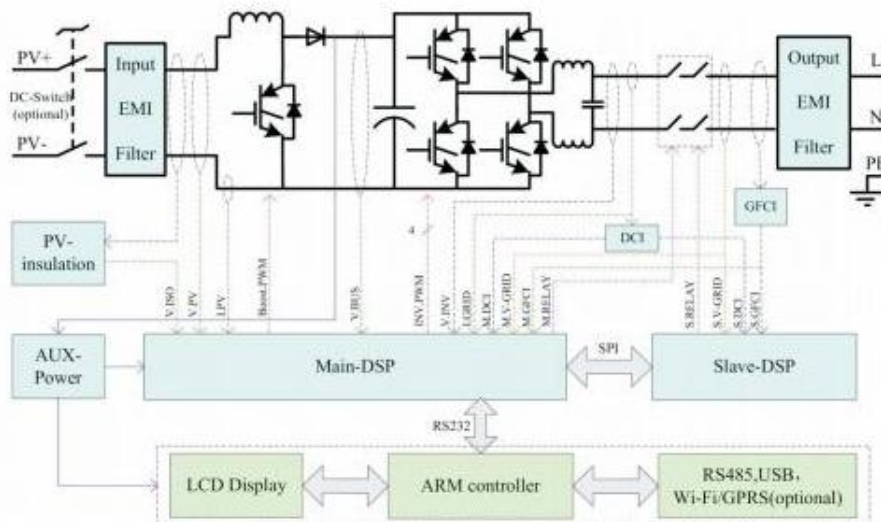



Models differences:

The models of SOFAR 1100TL-G3, SOFAR 1600TL-G3, SOFAR 2200TL-G3, SOFAR 2700TL-G3, SOFAR 3000TL-G3 and SOFAR 3300TL-G3 are identical on topological schematic circuit diagram and control solution codes. The difference between each other as following table:

| Model | SOFAR 1100 TL-G3 | SOFAR 1600 TL-G3 | SOFAR 2200 TL-G3 | SOFAR 2700 TL-G3 | SOFAR 3000 TL-G3 | SOFAR 3300 TL-G3 |
|---------------------|--------------------|------------------|------------------|--------------------|------------------|------------------|
| Heatsink size | 253*253.3*26.5mm | | | 271*253.3*40mm | | |
| Inverter inductance | 0.99mH * 2pcs | | | 0.676mH * 2 pcs | | |
| Bus capacitance | 470uF /500V* 2 pcs | | | 470uF/550V * 3 pcs | | |
| Size | 303*260.5*118 | | | 321*260.5*131.5 | | |

Other than special notes, typical model SOFAR 3300TL-G3 used as representative for testing in this report.

Copy of marking plate:

|  Solar Grid-tied Inverter | |
|---|----------------------|
| Model No. | SOFAR 3300TL-G3 |
| Max.DC Input Voltage | 550V |
| Operating MPPT Voltage Range | 50~550V |
| Max. Input Current | 12A |
| Max. PV Isc | 15A |
| Nominal Grid Voltage | L/N/PE,230Vac |
| Max. Output Current | 16A |
| Nominal Grid Frequency | 50/60Hz |
| Max. Output Power | 3300VA |
| Power Factor | 1 (adjustable+/-0.8) |
| Ingress protection | IP65 |
| Operating Temperature Range | -30~+60°C |
| Topology | Non-isolated |
| Protective Class | Class I |
| Manufacturer: Shenzhen SOFARSOLAR Co., Ltd. Address: 401, Building 4, AnTongDa Industrial Park, District 68, XingDong Community, XinAn Street, BaoAn District, Shenzhen, China VDE0126-1-1, VDE-AR-N4105, IEC61727, IEC62116, UTE C15-712-1, AS4777 | |
|  | |

Note:

1. The above markings are the minimum requirements required by the safety standard. For the final production samples, the additional markings which do not give rise to misunderstanding may be added.
2. Label is attached on the side surface of enclosure and visible after installation.
3. Other labels are identical to above, except the model name and ratings

| Engineering recommendation G98/1 | | | |
|---|---|-----------------|---------|
| Clause | Requirement – Test | Result – Remark | Verdict |
| 5 | Connection Procedure | | N/A |
| 5.1 | Single Premises Connection Procedure | | N/A |
| 5.2 | Multiple Premises Connection Procedure | | N/A |
| 6 | Certification Requirements | | P |
| 6.1 | Type Test Certification | | P |
| 6.1.1 | Type Tested certification is the responsibility of the Manufacturer. The Manufacturer shall make available upon request a Type Test Verification Report confirming that the Micro-generator has been tested to satisfy the requirements of this EREC G98. The report shall detail the type and model of Micro-generator tested, the test conditions and results recorded. All of these details shall be included in a Type Test Verification Report. The required verification report and declaration are shown in Appendix 3 Form C. It is intended that Manufacturers of Micro-generators will use the requirements of this EREC G98 to develop type verification certification for each of their Micro-generator models. | | P |
| 6.1.2 | Manufacturers of a Fully Type Tested Micro-generator should allocate a Manufacturer's reference number with the required details of the Micro-generator with the Energy Networks Association Type Test Verification Report Register. | | P |
| 6.2 | Compliance | | P |
| 6.2.1 | Compliance with the requirements detailed in this EREC G98 will ensure that the Micro-generator(s) is considered to be approved for connection to the DNO's Distribution Network. | | P |
| 6.2.2 | The Micro-generator(s) shall conform to all relevant European Directives and should be labelled with a CE marking. | | P |
| 7 | Operation and Safety | | N/A |
| 8 | Commissioning, Notification and Decommissioning | | N/A |
| 9 | General Technical Requirements | | P |
| 9.1 | Frequency withstand | | P |
| 9.1.1 | The Micro-generator shall be capable of remaining connected to the Distribution Network and operating within the frequency ranges and time periods specified in Table 1 unless disconnection was triggered by rate-of-change-of-frequency-type loss of mains protection. | | P |
| 9.2 | Rate of Change of Frequency | | P |
| 9.2.1 | With regard to the rate of change of frequency withstand capability, a Micro-generator shall be capable of staying connected to the Distribution Network and operate at rates of change of frequency up to 1.0 Hzs-1 measured over 500 ms. | | P |
| 9.3 | Limited Frequency Sensitive Mode – Overfrequency | | P |

| Engineering recommendation G98/1 | | | |
|---|--|--|---------|
| Clause | Requirement – Test | Result – Remark | Verdict |
| 9.3.1 | With regard to the Limited Frequency Sensitive Mode — Overfrequency (LFSM-O), the Micro-generator shall be capable of activating the provision of Active Power Frequency Response according to EN 50438. The GB specific standard frequency threshold shall be 50.4 Hz; the Droop setting shall be 10%. No intentional delay should be programmed to ensure that the initial delay is as short as possible with a maximum of 2 s. | No intentional delay setting | P |
| 9.3.2 | The Micro-generator will continue to reduce power with rising frequency with a Droop of 10% until 52.0 Hz, at which point the Micro-generator should disconnect. | | P |
| 9.4 | Active Power Output | | P |
| 9.4.1 | The Micro-generator shall be capable of maintaining constant output at its Registered Capacity regardless of changes in frequency, except where the output follows the changes defined in the context of paragraphs 9.3.1 and 9.4.2. | | P |
| 9.4.2 | The Micro-generator shall be capable of maintaining constant output at its Registered Capacity regardless of changes in frequency in the range 49.5 – 50.4 Hz. Below 49.5 Hz, the power output should not drop by more than pro-rata with frequency, ie the maximum permitted requirement is 100% power at 49.5 Hz falling linearly to 95% power at 47.0 Hz as illustrated in Figure 2. | | P |
| 9.4.3 | The Micro-generator shall be equipped with a logic interface (input port) in order to cease Active Power output within 5 s following an instruction being received from the DNO at the input port. By default the logic interface will take the form of a simple binary output that can be operated by a simple switch or contactor. When the switch is closed the Micro-generator can operate normally. When the switch is opened the Micro-generator will reduce its Active Power to zero within 5 s. The signal from the Micro-generator that is being switched can be either AC (maximum value 240 V) or DC (maximum value 110 V). The DNO may specify any additional requirements particularly regarding remote operation of this facility. | RJ 45 interface is used for logic interface (input port), nevertheless, the logic interface can also be installed in the end system. | P |
| 9.5 | Power Factor | A Fixed power factor at range 0.95 lagging to 0.95 leading | P |
| 9.5.1 | The power factor capability of the Micro-generator shall conform to EN 50438. When operating at Registered Capacity the Micro-generator shall operate at a power factor within the range 0.95 lagging to 0.95 leading relative to the voltage waveform unless otherwise agreed with the DNO eg for power factor improvement. | A Fixed power factor at range 0.95 lagging to 0.95 leading | P |
| 9.6 | Automatic Connection | | P |

| Engineering recommendation G98/1 | | | |
|---|--|---|---------|
| Clause | Requirement – Test | Result – Remark | Verdict |
| 9.6.1 | Micro-generators shall conform to EN 50438 in respect of connection and starting to generate electric power. This includes automatic reconnection where the minimum observation time shall be as stated in Annex A12 of EN 50438. | | P |
| 10 | Interface Protection | | P |
| 10.1 | General | | P |
| 10.1.1 | The Micro-generator shall conform to the Interface Protection settings set out below (Table 2). Means shall be provided to protect the settings from unpermitted interference (eg via a password or seal). | The settings for interface shall require a password or authored by manufactures | P |
| 10.1.2 | The DNO is responsible under the Distribution Code for ensuring, by design, that the voltage and frequency at the Connection Point remains within statutory limits. The Interface Protection settings have been chosen to allow for voltage rise or drop within the Customer's Installation and to allow the Micro-generator to continue to operate outside of the statutory frequency range as required by the EU Network Code on Requirements for Grid Connection of Generators. | | P |
| 10.1.3 | Interface Protection shall be installed which disconnects the Micro-generator from the DNO's Distribution Network when any parameter is outside of the settings shown in Table 2. | | P |
| 10.1.4 | The total disconnection time for voltage and frequency protection, including the operating time of the disconnection device, shall be the time delay setting with a tolerance of, -0s + 0.5 s. | | P |
| 10.1.5 | For the avoidance of doubt, where the Distribution Network voltage or frequency exceed the trip settings in Table 2, for less than the time delay setting, the Micro-generator should not disconnect from the Distribution Network. | | P |
| 10.1.6 | Fully Type Tested Micro-generators shall have protection settings set during manufacture. | | P |

| Engineering recommendation G98/1 | | | |
|---|---|-----------------------|---------|
| Clause | Requirement – Test | Result – Remark | Verdict |
| 10.1.7 | <p>The Manufacturer shall establish a secure way of displaying the Interface Protection setting information in one of the following ways:</p> <ul style="list-style-type: none"> ● A display on a screen; ● A display on a PC which can communicate with the Micro-generator and confirm that it is the correct Micro-generator by means of a serial number permanently fixed to the Micro-generator and visible on the PC screen at the same time as the settings; or ● Display of all Interface Protection settings and nominal voltage and current outputs, alongside the serial number of the Micro-generator, permanently fixed to the Micro-generator. | | P |
| 10.1.8 | <p>The provision of loose documents, documents attached to the Micro-generator by cable ties etc, or provision of data on adhesive paper based products which are not likely to survive due to fading, or failure of the adhesive, for at least 20 years is not acceptable.</p> | | P |
| 10.1.9 | <p>In response to a protection operation the Micro-generator shall be automatically disconnected from the DNO's Distribution Network. This disconnection must be achieved preferably by the separation of mechanical contacts or alternatively by the operation of a suitably rated solid state switching device. Where a solid state switching device is used to afford disconnection of the Micro-generator, the switching device shall incorporate fail safe monitoring to check the voltage level at its output stage. In the event that the solid state switching device fails to disconnect the Micro-generator, the voltage on the output side of the switching device shall be reduced to a value below 50 V within 0.5 s of the protection and trip delay timer operation.</p> | Disconnected by relay | P |
| 10.1.10 | <p>Where a common protection system is used to provide the protection function for multiple Micro-generators the complete installation cannot be considered to comprise Fully Type Tested Micro-generators if the protection and connections are made up on site and so cannot be factory tested or Fully Type Tested. In accordance with Annex A1 or Annex A2 if the units or Micro-generators are specifically designed with plugs and sockets to be interconnected on site, then provided the assembly passes the function tests required in Appendix 3 Form C, the Micro-generator(s) can retain Fully Type Tested status.</p> | | N/A |

| Engineering recommendation G98/1 | | | |
|---|---|-----------------|---------|
| Clause | Requirement – Test | Result – Remark | Verdict |
| 10.1.11 | Once the Micro-generator has been installed and commissioned the protection settings shall only be altered following written agreement between the DNO and the Customer or their agent. | | N/A |
| 10.2 | Loss of Mains Protection | | P |
| 10.2.1 | Loss of mains protection shall be incorporated and tested as defined in the compliance type testing annex of EN 50438. Active methods which use impedance measuring techniques by drawing current pulses from or injecting AC currents into the DNO's Distribution Network are not considered to be suitable. For Micro-generators which generate on more than one phase, the loss of mains protection should be able to detect the loss of a single phase of the supply network. This should be tested during type testing and recorded in the Type Test Verification Report as per Appendix 3 Form C. | | P |
| 10.3 | Frequency Drift and Step Change Stability Test | | P |
| 10.3.1 | Under normal operation of the Distribution Network, the frequency changes over time due to continuous unbalance of load and generation or can experience a step change due to the loss of a Distribution Network component which does not cause a loss of supply. | | P |
| 10.3.2 | In order to ensure that such phenomena do not cause unnecessary tripping of Micro-generators, stability type tests shall be carried out. | | P |
| 10.3.3 | The Rate of Change of Frequency (RoCoF) and Vector Shift values required for these tests are marginally less than the corresponding protection settings for RoCoF in Table 2 and vector shifts of up to 50°. Both stability tests shall be carried out in all cases. | | P |
| 10.3.4 | The stability tests are to be carried out as per the table in Appendix 3 Form C of this document and the Micro-generator should remain connected during each and every test. The tests shall check that the Micro-generator remains stable and connected during the following scenarios: <ul style="list-style-type: none"> ● RoCoF: 0.95 Hzs-1 from 49.0 Hz to 51.0 Hz on both rising and falling frequency; and ● Vector shift: 50° plus from 49.5 Hz and 50° minus from 50.5 Hz. | | P |
| 11 | Quality of Supply | | P |
| 11.1 | The power quality requirements set out in EN 50438 should be met along with the requirements described in this section of EREC G98. | | P |

| Engineering recommendation G98/1 | | | |
|---|---|-----------------|---------|
| Clause | Requirement – Test | Result – Remark | Verdict |
| 11.2 | Micro-generators are likely to be installed in large numbers on LV Distribution Networks. They are likely to operate for long periods with no diversity between them, and adjacent Micro-generators are likely to be of the same technology. Therefore, in order to accommodate a high number of Micro-generators on a Distribution Network, procedures are specified in Annex A1 and Annex A2, which need to be applied when testing for harmonic current emissions and flicker. | | P |
| 11.3 | The requirements of EN 50438 shall be met for DC injection. | | P |
| 12 | Short Circuit Current Contribution. | | P |
| 12.1 | Directly Coupled Micro-generators | | N/A |
| 12.2 | Inverter Connected Micro-generators | | P |
| Appendix 1 | Emerging Technologies and other Exceptions | | N/A |
| Appendix 2 | Connection Procedure Flow Chart | | N/A |
| Appendix 3 | Micro-generator Documentation | | N/A |
| Appendix 4 | Relaxation of Commissioning Notification Timescales for Micro-generator: HSE Certificate of Exemption (August 2008) | | N/A |
| A1 | Annex A1 Requirements for Type Testing of Inverter Connected Micro-generators | | P |
| A1.2 | Type Verification Functional Testing of the Interface Protection | | P |
| A1.2.1 | Disconnection times | | P |
| A1.2.2 | Over / Under Voltage | | P |
| A1.2.3 | Over / Under Frequency | | P |
| A1.2.4 | Loss of Mains Protection | | P |
| A1.2.5 | Reconnection | | P |
| A1.2.6 | Frequency Drift and Step Change Stability test | | P |
| A1.2.7 | Active power feed-in at under-frequency | | P |
| A1.2.8 | Power response to over-frequency | | P |
| A1.3 | POWER QUALITY | | P |
| A1.3.1 | Harmonics | | P |
| A1.3.2 | Power Factor | | P |
| A1.3.4 | DC Injection for Inverters | | P |
| A1.3.5 | Short Circuit Current Contribution for Inverters | | P |
| A1.3.6 | Self-Monitoring - Solid State Disconnection | | N/A |
| A1.3.7 | Electromagnetic Compatibility (EMC) | | P |

| Engineering recommendation G98/1 | | | |
|---|--|-----------------|---------|
| Clause | Requirement – Test | Result – Remark | Verdict |
| A.2 | Annex A2 Requirements for Type Testing of Synchronous Micro-generators | | N/A |

Appendix 1: Testing table

| <p>Operating Range: This test should be carried out as specified in EN 50438 D.3.1.</p> <p>Active Power shall be recorded every second. The tests will verify that the Micro-generator can operate within the required ranges for the specified period of time.</p> <p>The Interface Protection shall be disabled during the tests.</p> <p>In case of a PV Micro-generator the PV primary source may be replaced by a DC source.</p> <p>In case of a full converter Micro-generator (eg wind) the primary source and the prime mover Inverter/rectifier may be replaced by a DC source.</p> <p>In case of a DFIG Micro-generator the mechanical drive system may be replaced by a test bench motor.</p> | | | | | | | | | | | | | |
|---|--|--------------|----------------|--------------|----------------|---|------|------|------|------|------|------|------|
| <p>Test 1</p> <p>Voltage = 85% of nominal (195.5 V)</p> <p>Frequency = 47.5 Hz</p> <p>Power factor = 1</p> <p>Period of test 90 minutes</p> | <table border="1"> <caption>Test 1 Data</caption> <thead> <tr> <th>Time [s]</th> <th>Voltage [p.u.]</th> <th>Power [p.u.]</th> <th>Frequency [Hz]</th> </tr> </thead> <tbody> <tr> <td>0</td> <td>0.85</td> <td>1.00</td> <td>47.5</td> </tr> <tr> <td>6000</td> <td>0.85</td> <td>1.00</td> <td>47.5</td> </tr> </tbody> </table> | Time [s] | Voltage [p.u.] | Power [p.u.] | Frequency [Hz] | 0 | 0.85 | 1.00 | 47.5 | 6000 | 0.85 | 1.00 | 47.5 |
| Time [s] | Voltage [p.u.] | Power [p.u.] | Frequency [Hz] | | | | | | | | | | |
| 0 | 0.85 | 1.00 | 47.5 | | | | | | | | | | |
| 6000 | 0.85 | 1.00 | 47.5 | | | | | | | | | | |
| <p>Test 2</p> <p>Voltage = 110% of nominal (253 V).</p> <p>Frequency = 51.5 Hz</p> <p>Power factor = 1</p> <p>Period of test 90 minutes</p> | <table border="1"> <caption>Test 2 Data</caption> <thead> <tr> <th>Time [s]</th> <th>Voltage [p.u.]</th> <th>Power [p.u.]</th> <th>Frequency [Hz]</th> </tr> </thead> <tbody> <tr> <td>0</td> <td>1.10</td> <td>1.00</td> <td>51.5</td> </tr> <tr> <td>8000</td> <td>1.10</td> <td>1.00</td> <td>51.5</td> </tr> </tbody> </table> | Time [s] | Voltage [p.u.] | Power [p.u.] | Frequency [Hz] | 0 | 1.10 | 1.00 | 51.5 | 8000 | 1.10 | 1.00 | 51.5 |
| Time [s] | Voltage [p.u.] | Power [p.u.] | Frequency [Hz] | | | | | | | | | | |
| 0 | 1.10 | 1.00 | 51.5 | | | | | | | | | | |
| 8000 | 1.10 | 1.00 | 51.5 | | | | | | | | | | |
| <p>Test 3</p> <p>Voltage = 110% of nominal (253 V).</p> <p>Frequency = 52.0 Hz</p> <p>Power factor = 1</p> <p>Period of test 15 minutes</p> | <table border="1"> <caption>Test 3 Data</caption> <thead> <tr> <th>Time [s]</th> <th>Voltage [p.u.]</th> <th>Power [p.u.]</th> <th>Frequency [Hz]</th> </tr> </thead> <tbody> <tr> <td>0</td> <td>1.10</td> <td>1.00</td> <td>52.0</td> </tr> <tr> <td>1500</td> <td>1.10</td> <td>1.00</td> <td>52.0</td> </tr> </tbody> </table> | Time [s] | Voltage [p.u.] | Power [p.u.] | Frequency [Hz] | 0 | 1.10 | 1.00 | 52.0 | 1500 | 1.10 | 1.00 | 52.0 |
| Time [s] | Voltage [p.u.] | Power [p.u.] | Frequency [Hz] | | | | | | | | | | |
| 0 | 1.10 | 1.00 | 52.0 | | | | | | | | | | |
| 1500 | 1.10 | 1.00 | 52.0 | | | | | | | | | | |

Appendix 1: Testing table

| | | | | | | |
|---|---|--|------------------------------------|----|----------------------------------|---|
| Power Quality – Harmonics: These tests should be carried out as specified in BS EN 61000-3-2. The chosen test should be undertaken with a fixed source of energy at two power levels a) between 45 and 55% and b) at 100% of Registered Capacity. The test requirements are specified in Annex A1 A.1.3.1 (Inverter connected) or Annex A2 A.2.3.1 (Synchronous). | | | | | | |
| Micro-generator tested to BS EN 61000-3-2 | | | | | | |
| Model: SOFAR 3300TL-G3 | | | | | | |
| Micro-generator rating per phase (rpp) | | | 3.30 | kW | | |
| Harmonic | At 45-55% of Registered Capacity | | 100% of Registered Capacity | | | |
| | Measured Value MV in Amps | | Measured Value MV in Amps | | Limit in BS EN 61000-3-2 in Amps | Higher limit for odd harmonics 21 and above |
| 2 | 0.0104 | | 0.0138 | | 1.080 | |
| 3 | 0.0135 | | 0.1228 | | 2.300 | |
| 4 | 0.0052 | | 0.0031 | | 0.430 | |
| 5 | 0.0051 | | 0.0854 | | 1.140 | |
| 6 | 0.0032 | | 0.0040 | | 0.300 | |
| 7 | 0.0032 | | 0.0475 | | 0.770 | |
| 8 | 0.0022 | | 0.0018 | | 0.230 | |
| 9 | 0.0051 | | 0.0220 | | 0.400 | |
| 10 | 0.0034 | | 0.0024 | | 0.184 | |
| 11 | 0.0043 | | 0.0099 | | 0.330 | |
| 12 | 0.0034 | | 0.0021 | | 0.153 | |
| 13 | 0.0075 | | 0.0157 | | 0.210 | |
| 14 | 0.0012 | | 0.0033 | | 0.131 | |
| 15 | 0.0096 | | 0.0170 | | 0.150 | |
| 16 | 0.0021 | | 0.0052 | | 0.115 | |
| 17 | 0.0087 | | 0.0119 | | 0.132 | |

Appendix 1: Testing table

| | | | | | | |
|----|--------|--|--------|--|-------|-------|
| 18 | 0.0047 | | 0.0084 | | 0.102 | |
| 19 | 0.0102 | | 0.0091 | | 0.118 | |
| 20 | 0.0024 | | 0.0077 | | 0.092 | |
| 21 | 0.0087 | | 0.0103 | | 0.107 | 0.160 |
| 22 | 0.0027 | | 0.0060 | | 0.084 | |
| 23 | 0.0072 | | 0.0080 | | 0.098 | 0.147 |
| 24 | 0.0041 | | 0.0061 | | 0.077 | |
| 25 | 0.0099 | | 0.0077 | | 0.090 | 0.135 |
| 26 | 0.0012 | | 0.0046 | | 0.071 | |
| 27 | 0.0086 | | 0.0058 | | 0.083 | 0.124 |
| 28 | 0.0013 | | 0.0017 | | 0.066 | |
| 29 | 0.0106 | | 0.0090 | | 0.078 | 0.117 |
| 30 | 0.0016 | | 0.0019 | | 0.061 | |
| 31 | 0.0087 | | 0.0066 | | 0.073 | 0.109 |
| 32 | 0.0013 | | 0.0016 | | 0.058 | |
| 33 | 0.0082 | | 0.0057 | | 0.068 | 0.102 |
| 34 | 0.0027 | | 0.0028 | | 0.054 | |
| 35 | 0.0092 | | 0.0064 | | 0.064 | 0.096 |
| 36 | 0.0020 | | 0.0031 | | 0.051 | |
| 37 | 0.0081 | | 0.0051 | | 0.061 | 0.091 |
| 38 | 0.0022 | | 0.0021 | | 0.048 | |
| 39 | 0.0083 | | 0.0060 | | 0.058 | 0.087 |
| 40 | 0.0017 | | 0.0025 | | 0.046 | |

Note the higher limits for odd harmonics 21 and above are only allowable under certain conditions, if these higher limits are utilised please state the exemption used as detailed in part 6.2.3.4 of BS EN 61000-3-2 in the box below.

Appendix 1: Testing table

| Power Quality – Voltage fluctuations and Flicker: These tests should be undertaken in accordance with EREC G98 Annex A1 A.1.3.3 (Inverter connected) or Annex A2 A.2.3.3 (Synchronous). | | | | | | | | |
|---|----------|-----------------|------|----------|------|------------------|-----------------|-------------------------|
| | Starting | | | Stopping | | | Running | |
| | d max | d c | d(t) | d max | d c | d(t) | P _{st} | P _{lt} 2 hours |
| Measured Values at test impedance | -- | -- | -- | -- | -- | -- | -- | -- |
| Normalised to standard impedance | 0.12 | 0.00 | 0.00 | 0.12 | 0.00 | 0.00 | 0.07 | 0.07 |
| Normalised to required maximum impedance | -- | -- | -- | -- | -- | -- | -- | -- |
| Limits set under BS EN 61000-3-11 | 4% | 3.3% | 3.3% | 4% | 3.3% | 3.3% | 1.0 | 0.65 |
| | | | | | | | | |
| Test Impedance | R | 0.4 | Ω | X | | 0.25 | Ω | |
| Standard Impedance | R | 0.24 * 0.4 ^ | Ω | X | | 0.15 * 0.25 ^ | Ω | |
| Maximum Impedance | R | -- | Ω | X | | -- | Ω | |
| <p>Applies to three phase and split single phase Micro-generators.</p> <p>^ Applies to single phase Micro-generators and Micro-generators using two phases on a three phase system.</p> <p>For voltage change and flicker measurements the following formula is to be used to convert the measured values to the normalised values where the power factor of the generation output is 0.98 or above.</p> <p>Normalised value = Measured value*reference source resistance/measured source resistance at test point.</p> <p>Single phase units reference source resistance is 0.4 Ω</p> | | | | | | | | |

Appendix 1: Testing table

Two phase units in a three phase system reference source resistance is 0.4 Ω .

Two phase units in a split phase system reference source resistance is 0.24 Ω .

Three phase units reference source resistance is 0.24 Ω .

Where the power factor of the output is under 0.98 then the X to R ratio of the test impedance should be close to that of the Standard Impedance.

The stopping test should be a trip from full load operation.

The duration of these tests need to conform to the particular requirements set out in the testing notes for the technology under test. Dates and location of the test need to be noted below.

| | | | |
|-----------------|--|---------------|-------------|
| Test start date | 09 Oct 2019 | Test end date | 09 Oct 2019 |
| Test location | Block E, No.7-2 Guang Dong Software Science Park, Caipin Road, Guangzhou Science City, GETDD, Guangzhou, China | | |

Flicker Mode Uover: ■ ■ ■ ■
Iover: ■ ■ ■ ■ Flicker: Complete 2:00

Count 12/12
Interval 10m00s/10m00s

Element 1
Volt Range 300V/50Hz Element1 Judgement: Pass
Un (U1) 230.586 V Total Judgement: Pass
Freq(U1) 50.000 Hz (Element1)

| | dc[%] | dmax[%] | d(t)[ms] | Pst | P1t |
|--------|-----------|-----------|----------------|-----------|--------------|
| Limit | 3.30 | 4.00 | 500 3.30(%) | 1.00 | 0.65 N:12 |
| No. 1 | 0.00 Pass | 0.00 Pass | 0 Pass | 0.07 Pass | |
| 2 | 0.00 Pass | 0.00 Pass | 0 Pass | 0.07 Pass | |
| 3 | 0.00 Pass | 0.00 Pass | 0 Pass | 0.07 Pass | |
| 4 | 0.00 Pass | 0.00 Pass | 0 Pass | 0.07 Pass | |
| 5 | 0.00 Pass | 0.00 Pass | 0 Pass | 0.07 Pass | |
| 6 | 0.00 Pass | 0.00 Pass | 0 Pass | 0.07 Pass | |
| 7 | 0.10 Pass | 0.12 Pass | 0 Pass | 0.07 Pass | |
| 8 | 0.00 Pass | 0.00 Pass | 0 Pass | 0.07 Pass | |
| 9 | 0.00 Pass | 0.00 Pass | 0 Pass | 0.07 Pass | |
| 10 | 0.00 Pass | 0.00 Pass | 0 Pass | 0.07 Pass | |
| 11 | 0.00 Pass | 0.00 Pass | 0 Pass | 0.07 Pass | |
| 12 | 0.00 Pass | 0.00 Pass | 0 Pass | 0.07 Pass | |
| Result | Pass | Pass | Pass | Pass | 0.07 |

Update 3600 2019/10/09 11:57:29

YOKOGAWA ◆

Flicker Form

Measurement

Flicker dmax

Initialize Exec

Start

Reset

Flicker Settings

Appendix 1: Testing table

| Power quality – DC injection: This test should be carried out in accordance with EN 50438 Annex D.3.10 | | | | |
|---|--------|--------|--------|--------|
| Test power level | 20% | 50% | 75% | 100% |
| Recorded value in Amps | 0.0031 | 0.0031 | 0.0029 | 0.0025 |
| as % of rated AC current | 0.0216 | 0.0216 | 0.0202 | 0.0174 |
| Limit | 0.25% | 0.25% | 0.25% | 0.25% |

Appendix 1: Testing table

| Power Quality – Power factor: This test shall be carried out in accordance with EN 50538 Annex D.3.4.1 but with nominal voltage -6% and +10%. Voltage to be maintained within $\pm 1.5\%$ of the stated level during the test. | | | |
|---|---------|--------|--------|
| | 216.2 V | 230 V | 253 V |
| 20% of Registered Capacity | 0.9970 | 0.9965 | 0.9956 |
| 50% of Registered Capacity | 0.9990 | 0.9990 | 0.9989 |
| 75% of Registered Capacity | 0.9990 | 0.9990 | 0.9992 |
| 100% of Registered Capacity | 0.9990 | 0.9989 | 0.9992 |
| Limit | >0.95 | >0.95 | >0.95 |

Appendix 1: Testing table

| Protection – Frequency tests: These tests should be carried out in accordance with EN 50438 Annex D.2.4 and the notes in EREC G98 Annex A1 A.1.2.3 (Inverter connected) or Annex A2 A.2.2.3 (Synchronous) | | | | | | |
|--|-----------|------------|-----------|------------|--------------------|-----------------|
| Function | Setting | | Trip test | | “No trip tests” | |
| | Frequency | Time delay | Frequency | Time delay | Frequency /time | Confirm no trip |
| U/F stage 1 | 47.5 Hz | 20 s | 47.50Hz | 20.24s | 47.7 Hz 30s | No trip |
| U/F stage 2 | 47 Hz | 0.5 s | 47.0Hz | 0.523s | 47.2 Hz 19.5 s | 20.2s trip |
| | | | | | 46.8 Hz 0.45 s | 0.534s trip |
| O/F stage 1 | 52 Hz | 0.5 s | 52.02Hz | 0.530s | 51.8 Hz 120.0 s | No trip |
| | | | | | 52.2 Hz 0.45 s | 0.516s trip |

Note. For frequency trip tests the frequency required to trip is the setting ± 0.1 Hz. In order to measure the time delay a larger deviation than the minimum required to operate the projection can be used. The “No trip tests” need to be carried out at the setting ± 0.2 Hz and for the relevant times as shown in the table above to ensure that the protection will not trip in error.

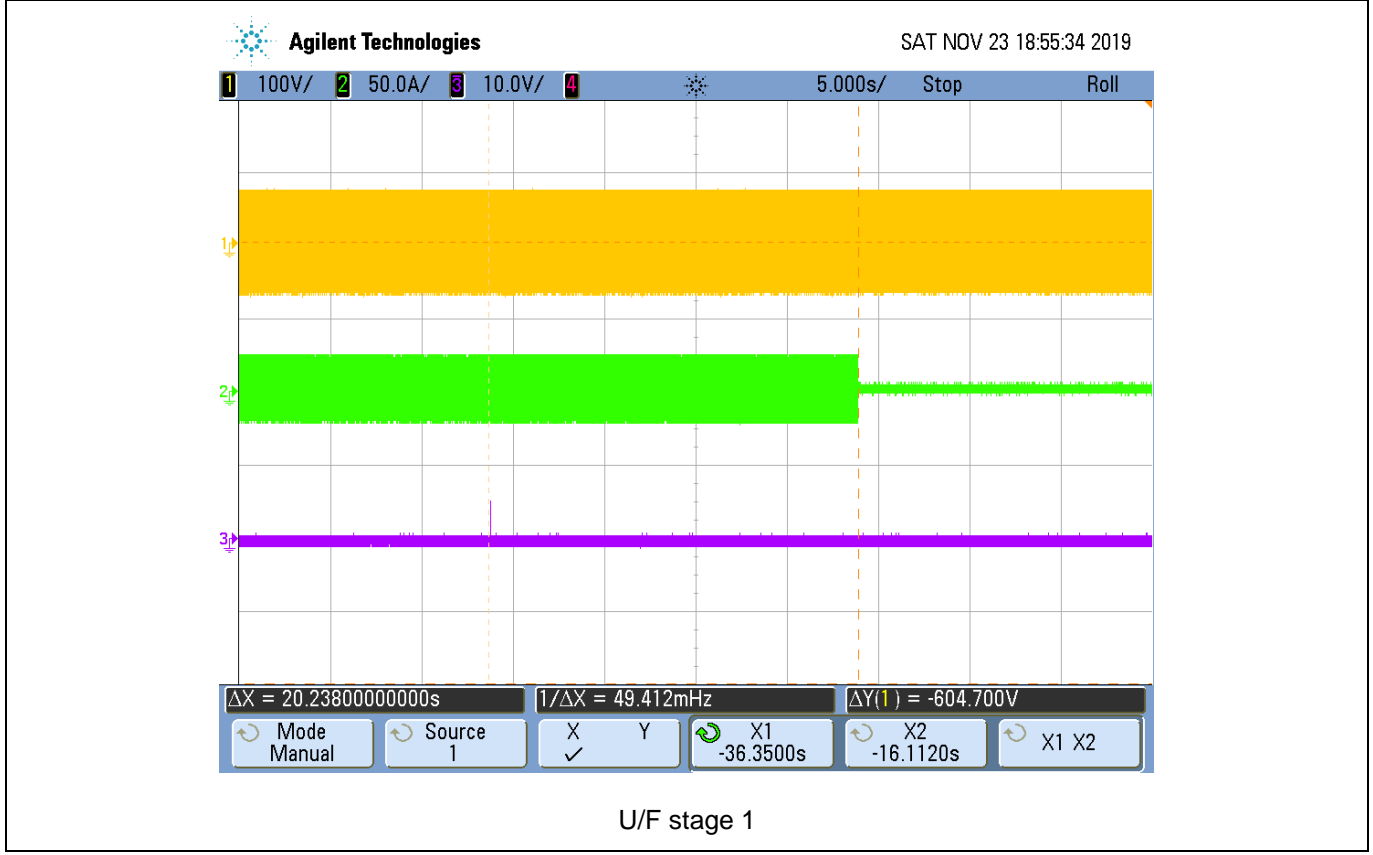

Appendix 1: Testing table

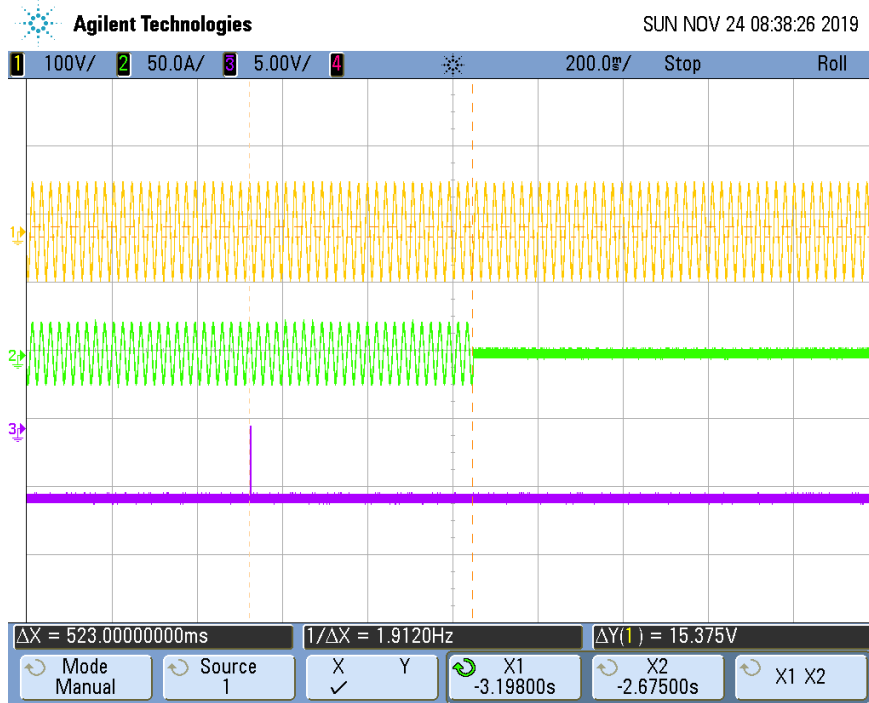

U/F stage 2

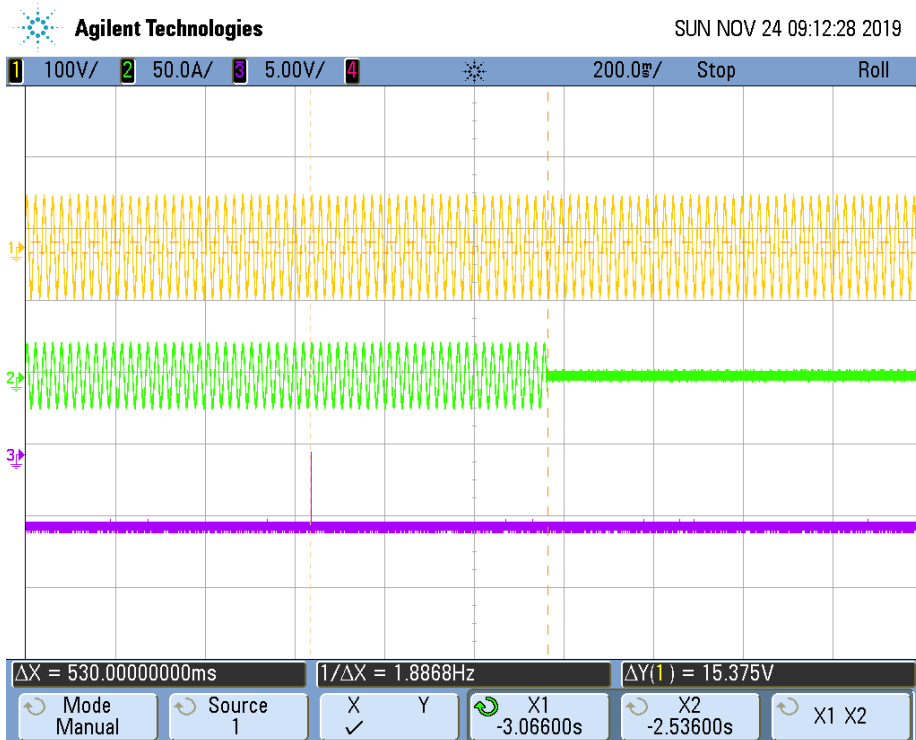

O/F stage 1

CH1: Voltage of EUT; CH2: Current of EUT; CH3: trip signal

Appendix 1: Testing table

| Protection – Voltage tests: These tests should be carried out in accordance with EN 50438 Annex D.2.3 and the notes in EREC G98 Annex A1 A.1.2.2 (Inverter connected) or Annex A2 A.2.2.2 (Synchronous) | | | | | | |
|--|---------|------------|-----------|------------|-------------------|-----------------|
| Function | Setting | | Trip test | | “No trip tests” | |
| | Voltage | Time delay | Voltage | Time delay | Voltage /time | Confirm no trip |
| U/V | 184 V | 2.5 s | 183.85V | 2.532s | 188 V 5.00 s | No trip |
| | | | | | 180 V 2.45 s | 2.52s trip |
| O/V stage 1 | 262.2 V | 1.0 s | 262.76V | 1.01s | 258.2 V 5.0 s | No trip |
| | | | | | 269.7 V 0.95 s | 1.01s trip |
| O/V stage 2 | 273.7 V | 0.5 s | 273.98V | 0.520s | 277.7 V 0.45 s | 0.524s trip |

Note for Voltage tests the Voltage required to trip is the setting ± 3.45 V. The time delay can be measured at a larger deviation than the minimum required to operate the protection. The No trip tests need to be carried out at the setting ± 4 V and for the relevant times as shown in the table above to ensure that the protection will not trip in error.

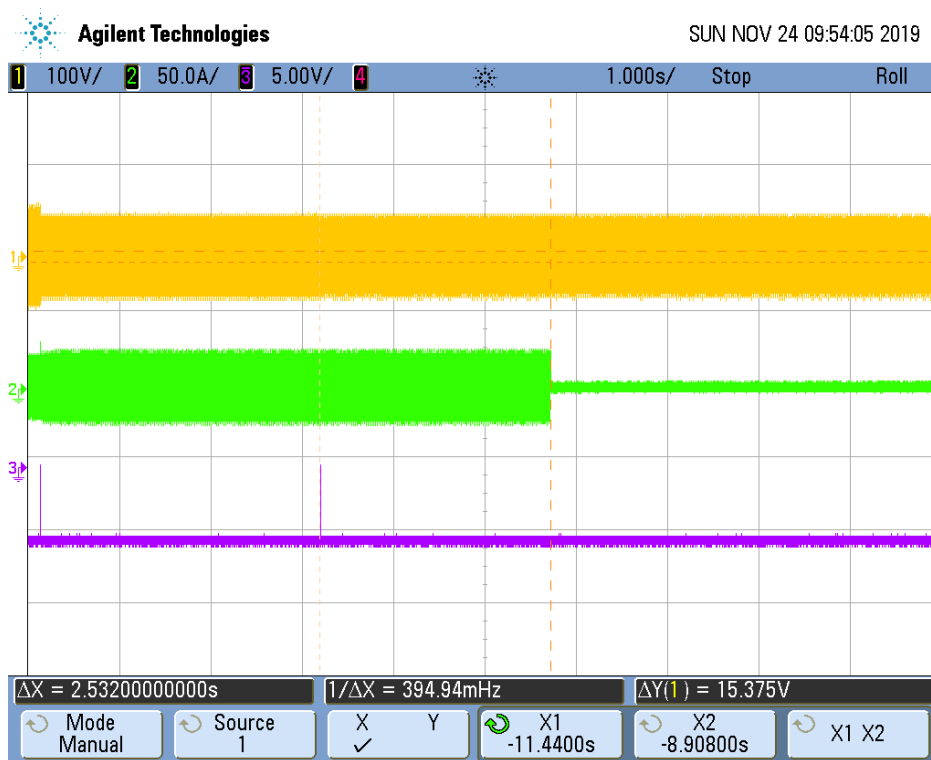

U/V

CH1: Voltage of EUT; CH2: Current of EUT; CH3: trip signal

Appendix 1: Testing table

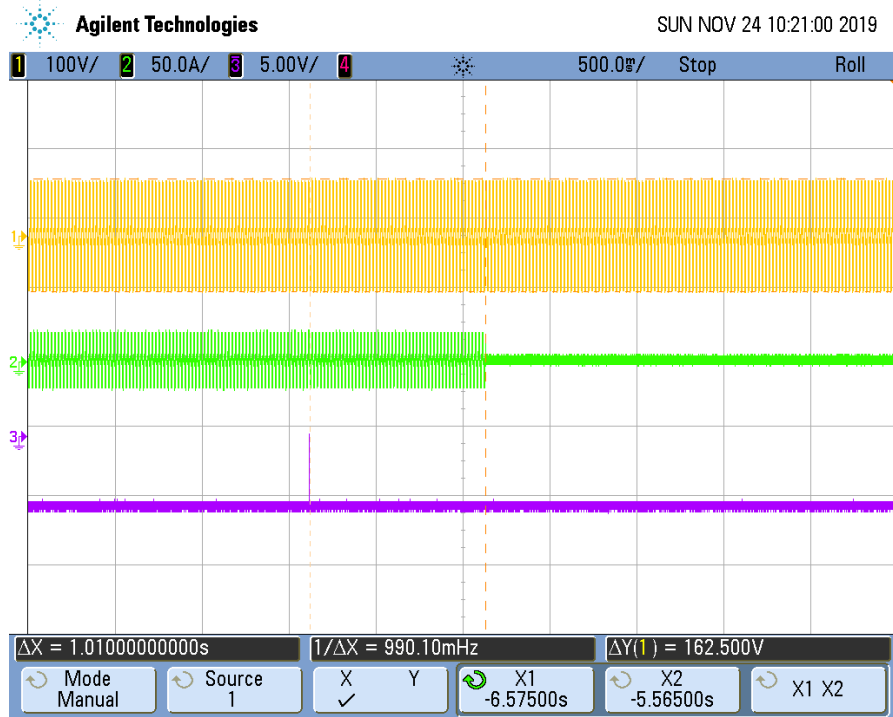

O/V stage 1

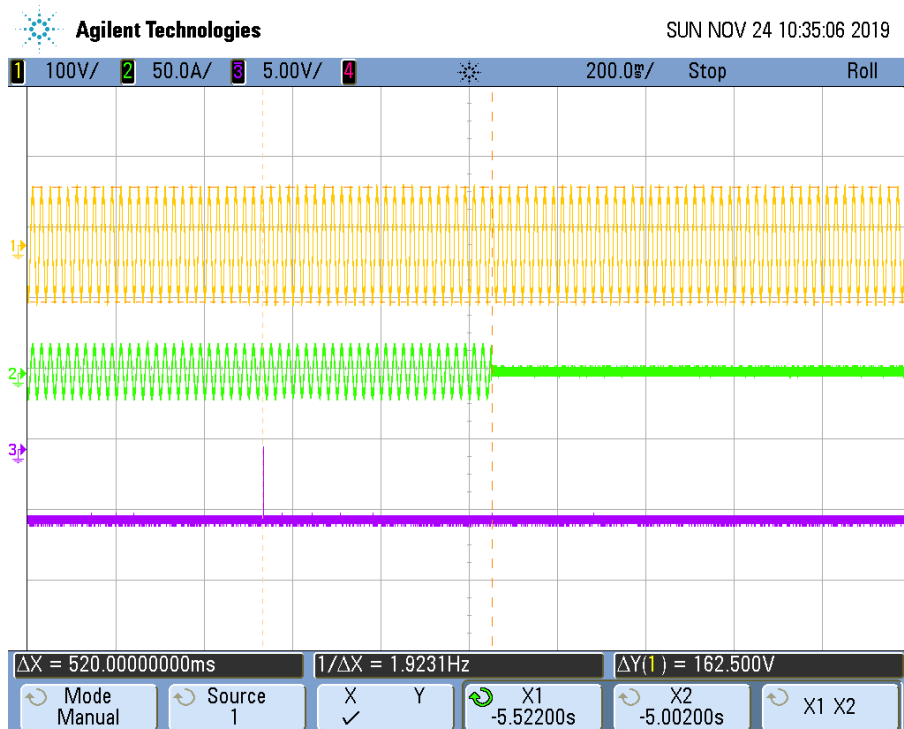

O/V stage 2

CH1: Voltage of EUT; CH2: Current of EUT; CH3: trip signal

Appendix 1: Testing table

| | | | | | | |
|---|-----------------------------------|-----------------------------------|-----------------------------------|------------------------------------|------------------------------------|------------------------------------|
| Protection – Loss of Mains test: For PV Inverters shall be tested in accordance with BS EN 62116. Other Inverters should be tested in accordance with EN 50438 Annex D.2.5 at 10%, 55% and 100% of rated power. | | | | | | |
| To be carried out at three output power levels with a tolerance of plus or minus 5% in Test Power levels. | | | | | | |
| Test Power | 10% | 55% | 100% | 10% | 55% | 100% |
| Balancing load on islanded network | 95% of Registered Capacity | 95% of Registered Capacity | 95% of Registered Capacity | 105% of Registered Capacity | 105% of Registered Capacity | 105% of Registered Capacity |
| Trip time. Limit is 0.5 s | -- | -- | -- | -- | -- | -- |
| For Multi phase Micro-generators confirm that the device shuts down correctly after the removal of a single fuse as well as operation of all phases. | | | | | | |
| Test Power | 10% | 55% | 100% | 10% | 55% | 100% |
| Balancing load on islanded network | 95% of Registered Capacity | 95% of Registered Capacity | 95% of Registered Capacity | 105% of Registered Capacity | 105% of Registered Capacity | 105% of Registered Capacity |
| Trip time. Ph1 fuse removed | -- | -- | -- | -- | -- | -- |
| Test Power | 10% | 55% | 100% | 10% | 55% | 100% |
| Balancing load on islanded network | 95% of Registered Capacity | 95% of Registered Capacity | 95% of Registered Capacity | 105% of Registered Capacity | 105% of Registered Capacity | 105% of Registered Capacity |
| Trip time. Ph2 fuse removed | -- | -- | -- | -- | -- | -- |
| Test Power | 10% | 55% | 100% | 10% | 55% | 100% |
| Balancing load on islanded network | 95% of Registered Capacity | 95% of Registered Capacity | 95% of Registered Capacity | 105% of Registered Capacity | 105% of Registered Capacity | 105% of Registered Capacity |
| Trip time. Ph3 fuse removed | -- | -- | -- | -- | -- | -- |
| Note for technologies which have a substantial shut down time this can be added to the 0.5 s in establishing that the trip occurred in less than 0.5 s. Maximum shut down time could therefore be up to 1.0 s for these technologies. | | | | | | |
| Indicate additional shut down time included in above results | | | | | ms | |
| For Inverters tested to BS EN 62116 the following sub set of tests should be recorded in the following table. | | | | | | |

Appendix 1: Testing table

| | | | | | | |
|------------------------------|-------------------------|-------------------------|-------------------------|-------------------------|-------------------------|--------------------------|
| Test Power and imbalance | 33% -5% Q Test 22 | 66% -5% Q Test 12 | 100% -5% P Test 5 | 33% +5% Q Test 31 | 66% +5% Q Test 21 | 100% +5% P Test 10 |
| Trip time. Limit is 0.5 s | 296ms | 328ms | 422ms | 362ms | 328ms | 446ms |

Appendix 1: Testing table

| Protection – Frequency change, Vector Shift Stability test: This test should be carried out in accordance with EREC G98 Annex A1 A.1.2.6 (Inverter connected) or Annex A2 A.2.2.6 (Synchronous). | | | |
|---|-----------------|--------------|-----------------|
| | Start Frequency | Change | Confirm no trip |
| Positive Vector Shift | 49.0 Hz | +50 degrees | No trip |
| Negative Vector Shift | 50.0 Hz | - 50 degrees | No trip |

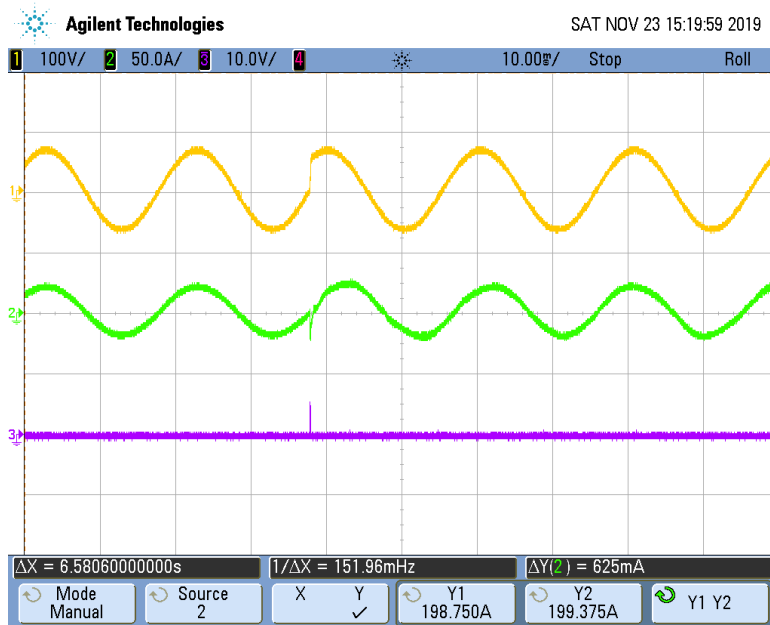

Positive Vector Shift

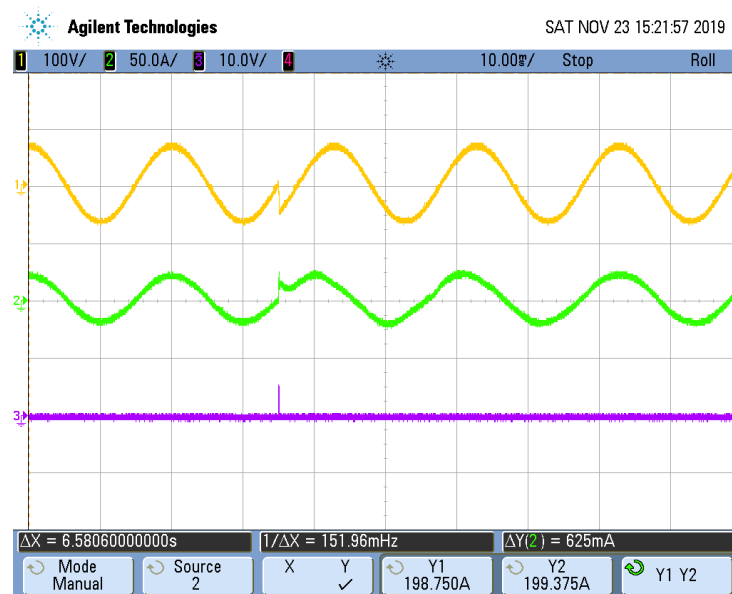

Negative Vector Shift

Appendix 1: Testing table

| Protection – Frequency change, RoCoF Stability test: The requirement is specified in section 11.3, test procedure in Annex A.1.2.6 (Inverter connected) or Annex A2 A.2.2.6 (Synchronous). | | | |
|---|-------------------------|---------------|-----------------|
| Ramp range | Test frequency ramp: | Test Duration | Confirm no trip |
| 49.0 Hz to 51.0 Hz | +0.95 Hzs ⁻¹ | 2.1 s | No trip |
| 51.0 Hz to 49.0 Hz | -0.95 Hzs ⁻¹ | 2.1 s | No trip |

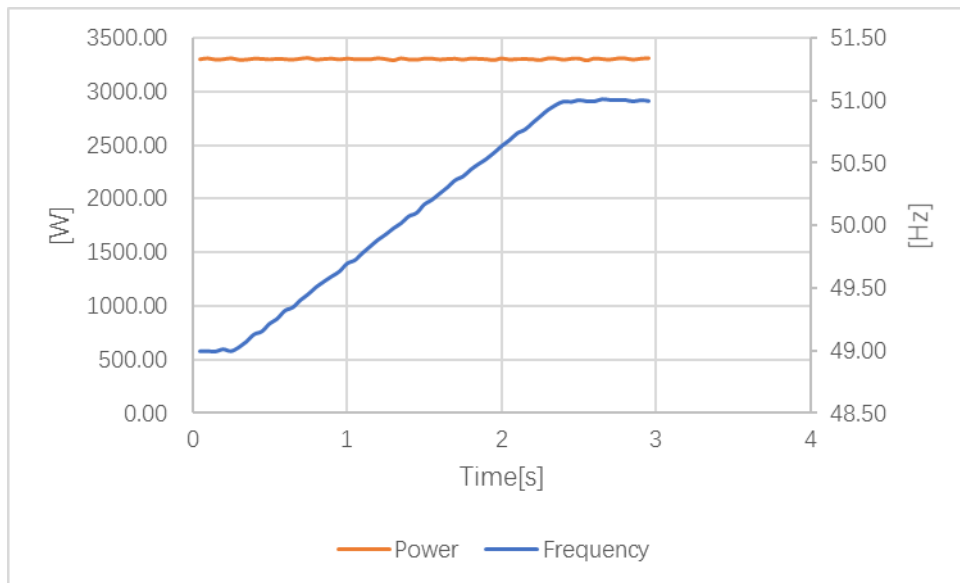

49.0 Hz to 51.0 Hz

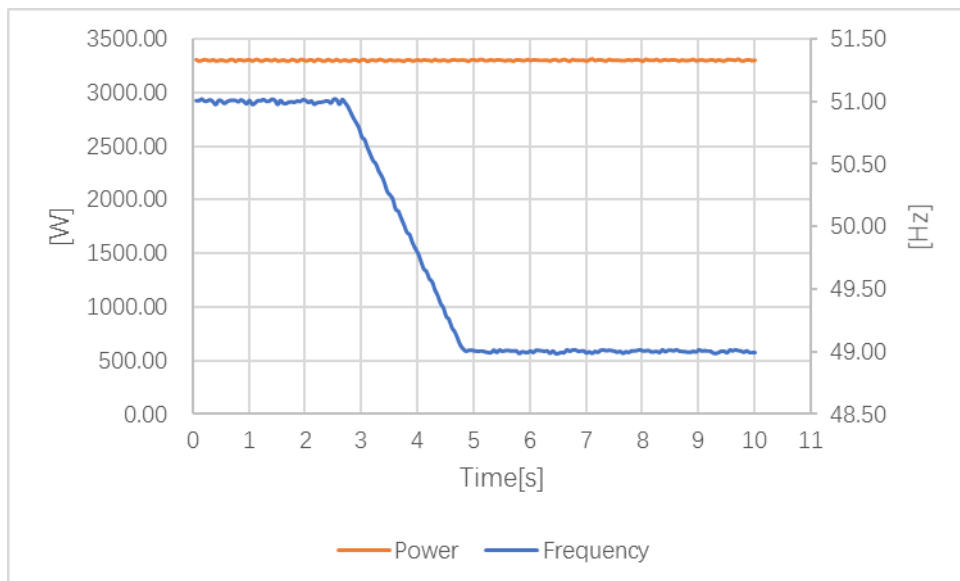

51.0 Hz to 49.0 Hz

Appendix 1: Testing table

| Limited Frequency Sensitive Mode – Overfrequency test: This test should be carried out in accordance with EN 50438 Annex D.3.3 Power response to over- frequency. The test should be carried out using the specific threshold frequency of 50.4 Hz and Droop of 10%. | | | | |
|--|-------------------------------------|-----------|----------------------|---------------------------------------|
| Test sequence at Registered Capacity >80% | Measured Active Power Output | Frequency | Primary Power Source | Active Power Gradient Droop(%) |
| Step a) 50.00 Hz ±0.01 Hz | 3303.99W | 50.00Hz | 3423.37W | N/A |
| Step b) 50.45 Hz ±0.05 Hz | 3255.51W | 50.47Hz | | 9.71 |
| Step c) 50.70 Hz ±0.10 Hz | 3115.42W | 50.70Hz | | 10.56 |
| Step d) 51.15 Hz ±0.05 Hz | 2816.87W | 51.15Hz | | 10.19 |
| Step e) 50.70 Hz ±0.10 Hz | 3115.34W | 50.70Hz | | 10.55 |
| Step f) 50.45 Hz ±0.05 Hz | 3255.21W | 50.47Hz | | 9.65 |
| Step g) 50.00 Hz ±0.01 Hz | 3302.29W | 50.00Hz | | N/A |
| Test sequence at Registered Capacity 40% - 60% | Measured Active Power Output | Frequency | Primary Power Source | Active Power Gradient Droop(%) |
| Step a) 50.00 Hz ±0.01 Hz | 1649.47W | 50.00Hz | 1881.73W | N/A |
| Step b) 50.45 Hz ±0.05 Hz | 1626.12W | 50.47Hz | | 9.88 |
| Step c) 50.70 Hz ±0.10 Hz | 1552.27W | 50.70Hz | | 10.18 |
| Step d) 51.15 Hz ±0.05 Hz | 1403.82W | 51.15Hz | | 10.07 |
| Step e) 50.70 Hz ±0.10 Hz | 1552.15W | 50.70Hz | | 10.17 |
| Step f) 50.45 Hz ±0.05 Hz | 1626.33W | 50.47Hz | | 9.97 |
| Step g) 50.00 Hz ±0.01 Hz | 1649.51W | 50.00Hz | | N/A |
| Steps as defined in EN 50438 | | | | |

Appendix 1: Testing table

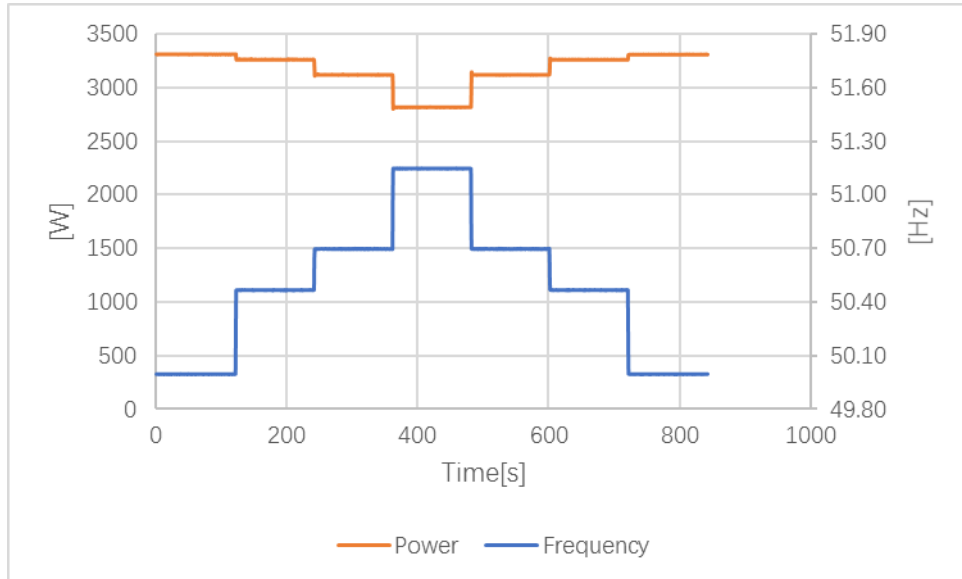

Test at Registered Capacity of 100%

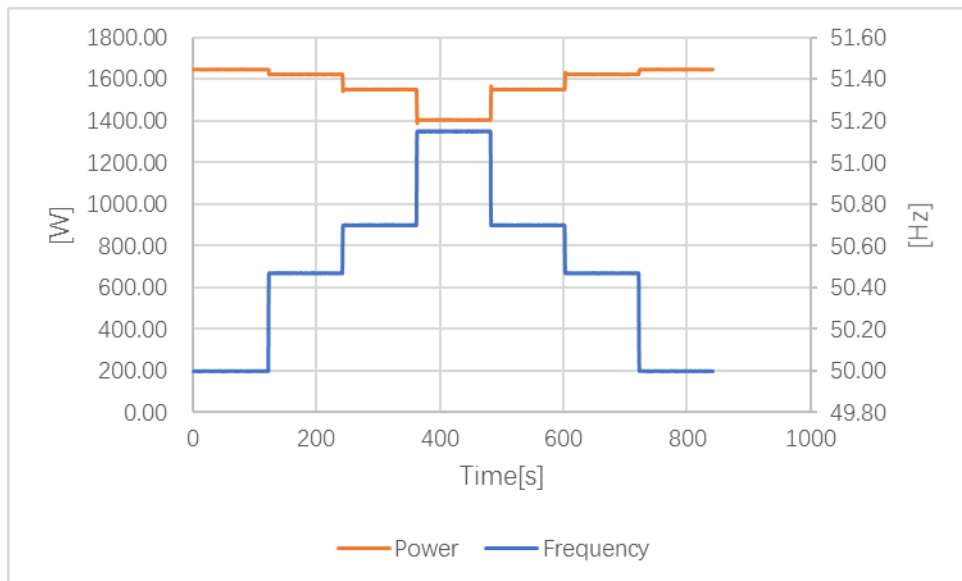

Test at Registered Capacity of 50%

Appendix 1: Testing table

| Power output with falling frequency test: This test should be carried out in accordance with EN 50438 Annex D.3.2 active power feed-in at under-frequency. | | | |
|---|-------------------------------------|-----------|----------------------|
| Test sequence | Measured Active Power Output | Frequency | Primary power source |
| Test a) 50 Hz ± 0.01 Hz | 3308.73W | 50.00Hz | 3424.16W |
| Test b) Point between 49.5 Hz and 49.6 Hz | 3308.70W | 49.55Hz | 3424.16W |
| Test c) Point between 47.5 Hz and 47.6 Hz | 3309.24W | 47.55Hz | 3425.31W |

NOTE: The operating point in Test (b) and (c) shall be maintained for at least 5 minutes

| Time [s] | Power [W] | Frequency [Hz] |
|----------|-----------|----------------|
| 0 | 3424.16 | 50.00 |
| 300 | 3424.16 | 49.55 |
| 600 | 3424.16 | 47.55 |
| 1000 | 3424.16 | 47.55 |

Appendix 1: Testing table

| Re-connection timer. | | | | | | |
|---|----------------|------------------|---|------------------|------------------|------------------|
| Test should prove that the reconnection sequence starts after a minimum delay of 20 s for restoration of voltage and frequency to within the stage 1 settings of Table 2. | | | | | | |
| Time delay setting | Measured delay | | Checks on no reconnection when voltage or frequency is brought to just outside stage 1 limits of table 2. | | | |
| 20s | 78.5s | | At 266.2 V | At 180.0 V | At 47.4 Hz | At 52.1 Hz |
| Confirmation that the Micro-generator does not re-connect. | | Not reconnection | Not reconnection | Not reconnection | Not reconnection | Not reconnection |

| Fault level contribution: These tests shall be carried out in accordance with EREC G98 Annex A1 A.1.3.5 (Inverter connected) and Annex A2 A.2.3.4 (Synchronous). | | | | | |
|--|----------|-------|----------------------------|---------|------------|
| For machines with electro-magnetic output | | | For Inverter output | | |
| Parameter | Symbol | Value | Time after fault | Volts | Amps |
| Peak Short Circuit current | i_p | -- | 20 ms | 157.6V | 20.22A |
| Initial Value of aperiodic current | A | -- | 100 ms | 160.19V | 21.08A |
| Initial symmetrical short-circuit current* | I_k | -- | 250 ms | -- | -- |
| Decaying (aperiodic) component of short circuit current* | i_{DC} | -- | 500 ms | -- | -- |
| Reactance/Resistance Ratio of source* | X/R | 2.5 | Time to trip | 0.133 | In seconds |
| For rotating machines and linear piston machines the test should produce a 0 s – 2 s plot of the short circuit current as seen at the Micro-generator terminals. | | | | | |
| * Values for these parameters should be provided where the short circuit duration is sufficiently long to enable interpolation of the plot | | | | | |

Appendix 1: Testing table

| | |
|---|-----|
| Logic Interface. | Yes |
| Self-Monitoring solid state switching: No specified test requirements. Refer to EREC G98 Annex A1 A.1.3.6 (Inverter connected). | NA |
| It has been verified that in the event of the solid state switching device failing to disconnect the Micro-generator , the voltage on the output side of the switching device is reduced to a value below 50 V within 0.5 s. | NA |
| Additional comments | |
| This equipment is equipped with RJ45 terminal for logic interface that being received the signal from the DNO, the connection should be installed per installation manual, and the signal should be a simple binary output that captured by RJ45 terminal(PIN 5 and 6 for detecting the signal). Once the signal actived, the inverter will reduce its active power to zero within 5s. | |

Appendix 1: Testing table

| Protection.Loss of Mains (LoM) detection The requirement is specified in section 5.3.2, test procedure in Annex A as an alternative, inverters can be tested to BS EN 62116. | | | | | | | | | P |
|---|---|------------------------------------|-------------------------------------|-------------------------------------|------------------|-----------|-----------|-----|-----------------------|
| No. | PEUT ¹⁾ (% of EUT rating) | Reactive load (% of QL in 6.1.d)1) | PAC ²⁾ (% of nominal) | QAC ³⁾ (% of nominal) | Run on time (ms) | PEUT (KW) | Actual Qf | VDC | Remarks ⁴⁾ |
| 1 | 100 | 100 | 0 | 0 | 456.0 | 3.31 | 1.00 | 500 | Test A at BL |
| 2 | 66 | 66 | 0 | 0 | 412.0 | 2.18 | 1.00 | 300 | Test B at BL |
| 3 | 33 | 33 | 0 | 0 | 376.0 | 1.12 | 1.00 | 130 | Test C at BL |
| 4 | 100 | 100 | -5 | -5 | 348.0 | 3.31 | 1.02 | 500 | Test A at IB |
| 5 | 100 | 100 | -5 | 0 | 422.0 | 3.31 | 0.96 | 500 | Test A at IB |
| 6 | 100 | 100 | -5 | 5 | 454.0 | 3.31 | 0.93 | 500 | Test A at IB |
| 7 | 100 | 100 | 0 | -5 | 404.0 | 3.31 | 1.04 | 500 | Test A at IB |
| 8 | 100 | 100 | 0 | 5 | 444.0 | 3.31 | 0.96 | 500 | Test A at IB |
| 9 | 100 | 100 | 5 | -5 | 368.0 | 3.31 | 1.08 | 500 | Test A at IB |
| 10 | 100 | 100 | 5 | 0 | 446.0 | 3.31 | 1.05 | 500 | Test A at IB |
| 11 | 100 | 100 | 5 | 5 | 320.0 | 3.31 | 1.01 | 500 | Test A at IB |
| 12 | 66 | 66 | 0 | -5 | 328.0 | 2.18 | 1.05 | 300 | Test B at IB |
| 13 | 66 | 66 | 0 | -4 | 356.0 | 2.18 | 1.03 | 300 | Test B at IB |
| 14 | 66 | 66 | 0 | -3 | 336.0 | 2.18 | 1.03 | 300 | Test B at IB |
| 15 | 66 | 66 | 0 | -2 | 344.0 | 2.18 | 1.02 | 300 | Test B at IB |
| 16 | 66 | 66 | 0 | -1 | 314.0 | 2.18 | 1.01 | 300 | Test B at IB |
| 17 | 66 | 66 | 0 | 1 | 364.0 | 2.18 | 1.00 | 300 | Test B at IB |
| 18 | 66 | 66 | 0 | 2 | 410.0 | 2.18 | 0.99 | 300 | Test B at IB |
| 19 | 66 | 66 | 0 | 3 | 426.0 | 2.18 | 0.98 | 300 | Test B at IB |
| 20 | 66 | 66 | 0 | 4 | 350.0 | 2.18 | 0.98 | 300 | Test B at IB |
| 21 | 66 | 66 | 0 | 5 | 328.0 | 2.18 | 0.97 | 300 | Test B at IB |
| 22 | 33 | 33 | 0 | -5 | 296.0 | 1.12 | 1.04 | 130 | Test C at IB |
| 23 | 33 | 33 | 0 | -4 | 350.0 | 1.12 | 1.03 | 130 | Test C at IB |
| 24 | 33 | 33 | 0 | -3 | 360.0 | 1.12 | 1.02 | 130 | Test C at IB |
| 25 | 33 | 33 | 0 | -2 | 352.0 | 1.12 | 1.02 | 130 | Test C at IB |
| 26 | 33 | 33 | 0 | -1 | 388.0 | 1.12 | 1.01 | 130 | Test C at IB |
| 27 | 33 | 33 | 0 | 1 | 396.0 | 1.12 | 0.99 | 130 | Test C at IB |
| 28 | 33 | 33 | 0 | 2 | 418.0 | 1.12 | 0.99 | 130 | Test C at IB |
| 29 | 33 | 33 | 0 | 3 | 382.0 | 1.12 | 0.98 | 130 | Test C at IB |
| 30 | 33 | 33 | 0 | 4 | 380.0 | 1.12 | 0.98 | 130 | Test C at IB |
| 31 | 33 | 33 | 0 | 5 | 362.0 | 1.12 | 0.97 | 130 | Test C at IB |

Appendix 2: Photos

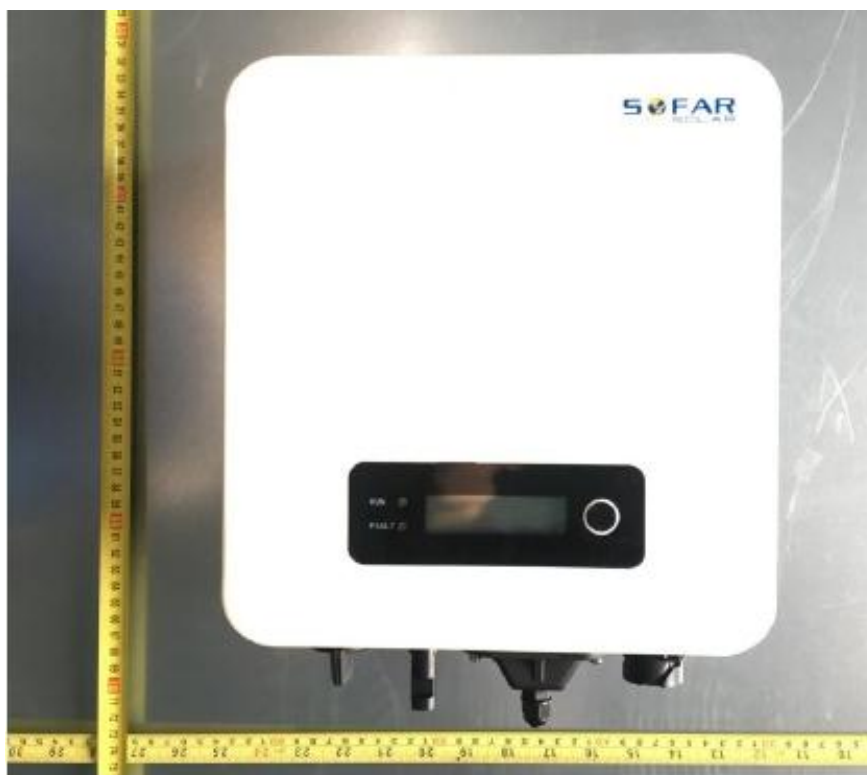

Overview

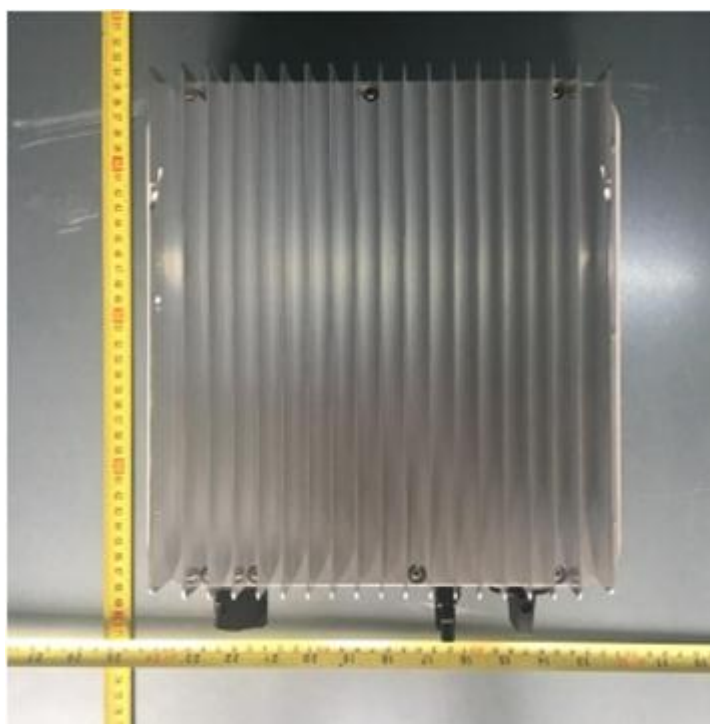

Rear view

Appendix 2: Photos



Connection Interface



Internal view

(End of Report)